

# Modeling Interdependencies between the Electricity and Information Infrastructures

Jean-Claude Laprie, Karama Kanoun, Mohamed Kaâniche

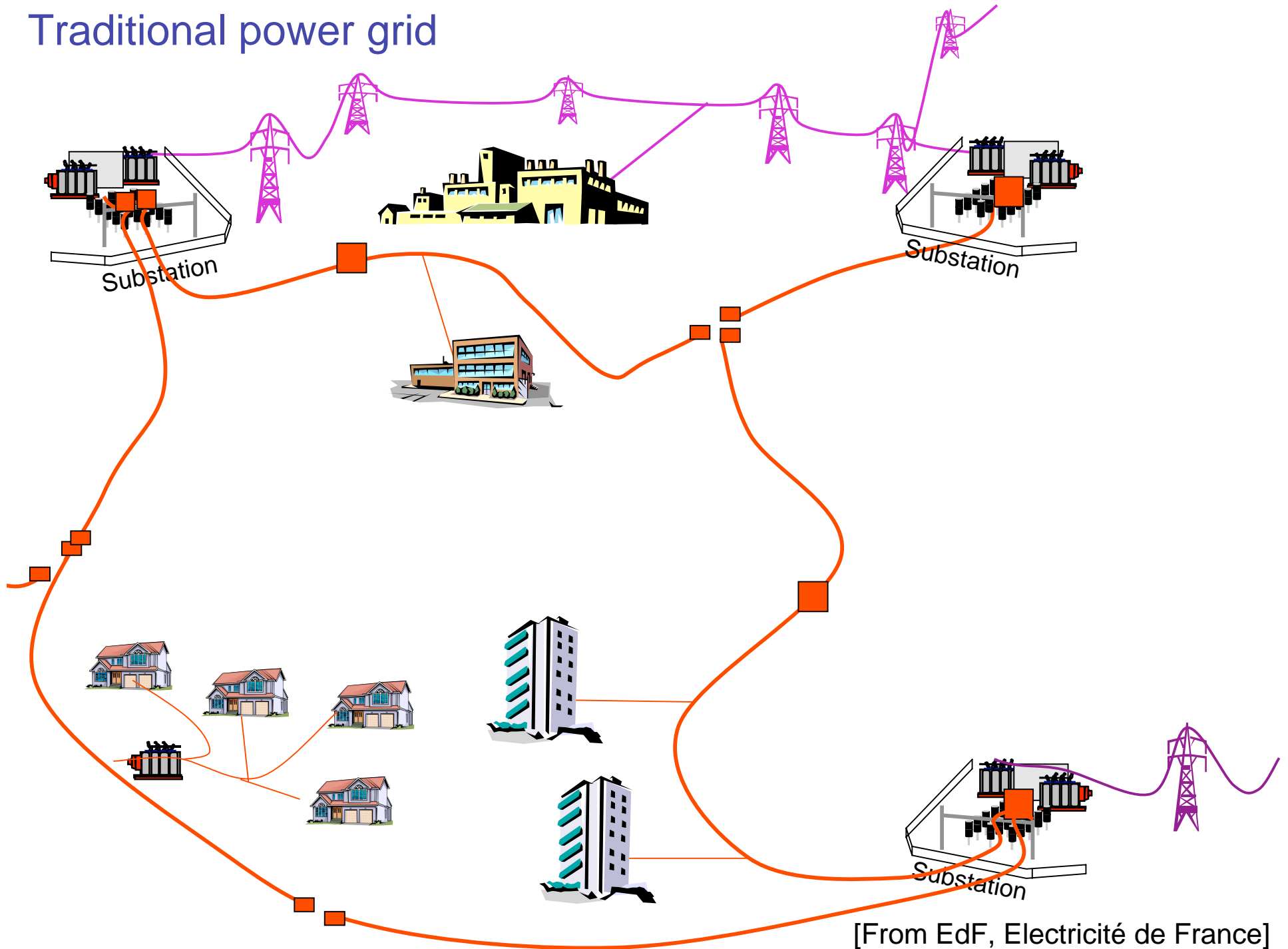

# Traditional power grid



[From EdF, Electricité de France]

# Penetration of distributed energy resources

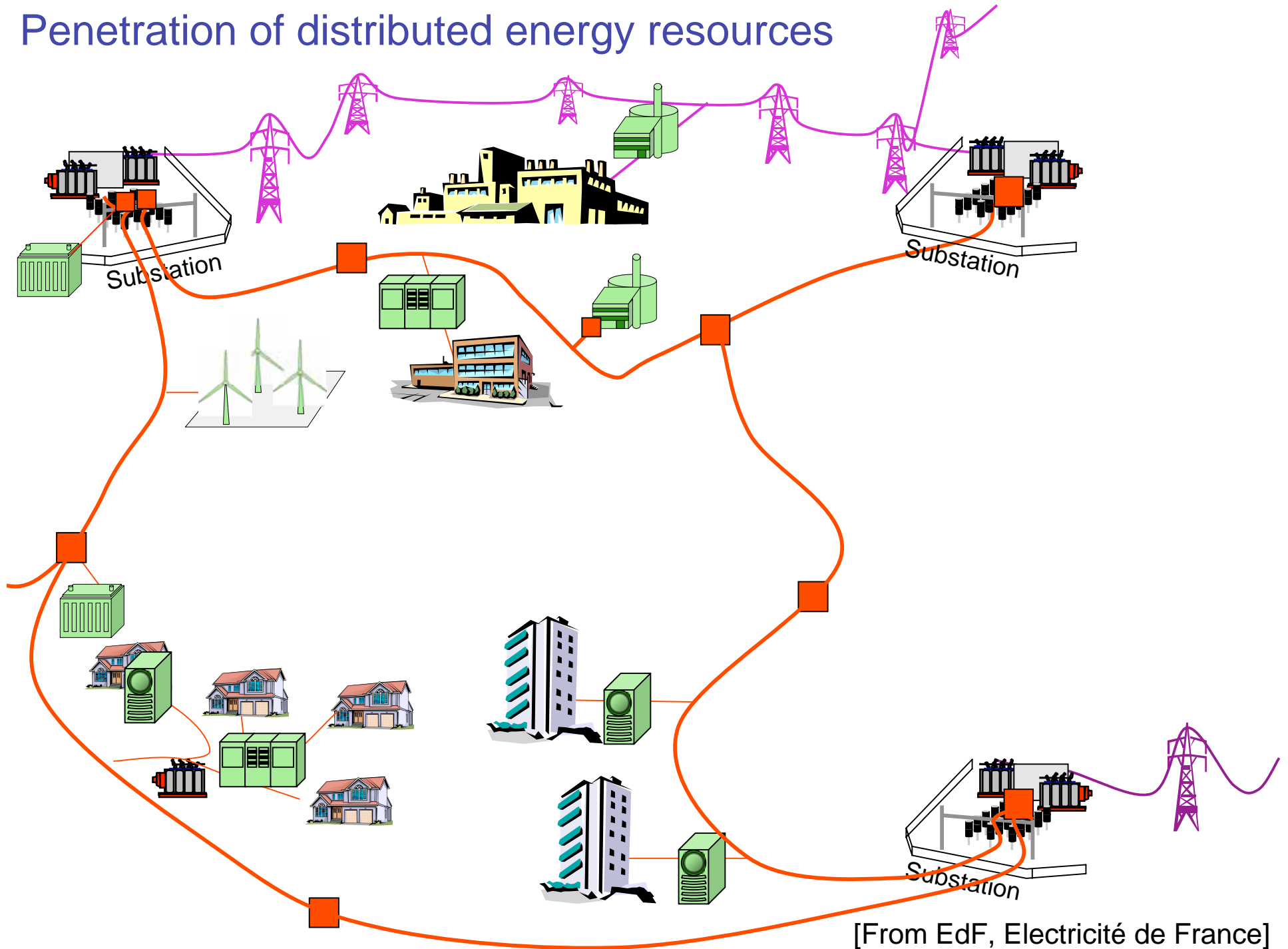

[From EdF, Electricité de France]

# Information infrastructures for grid operation

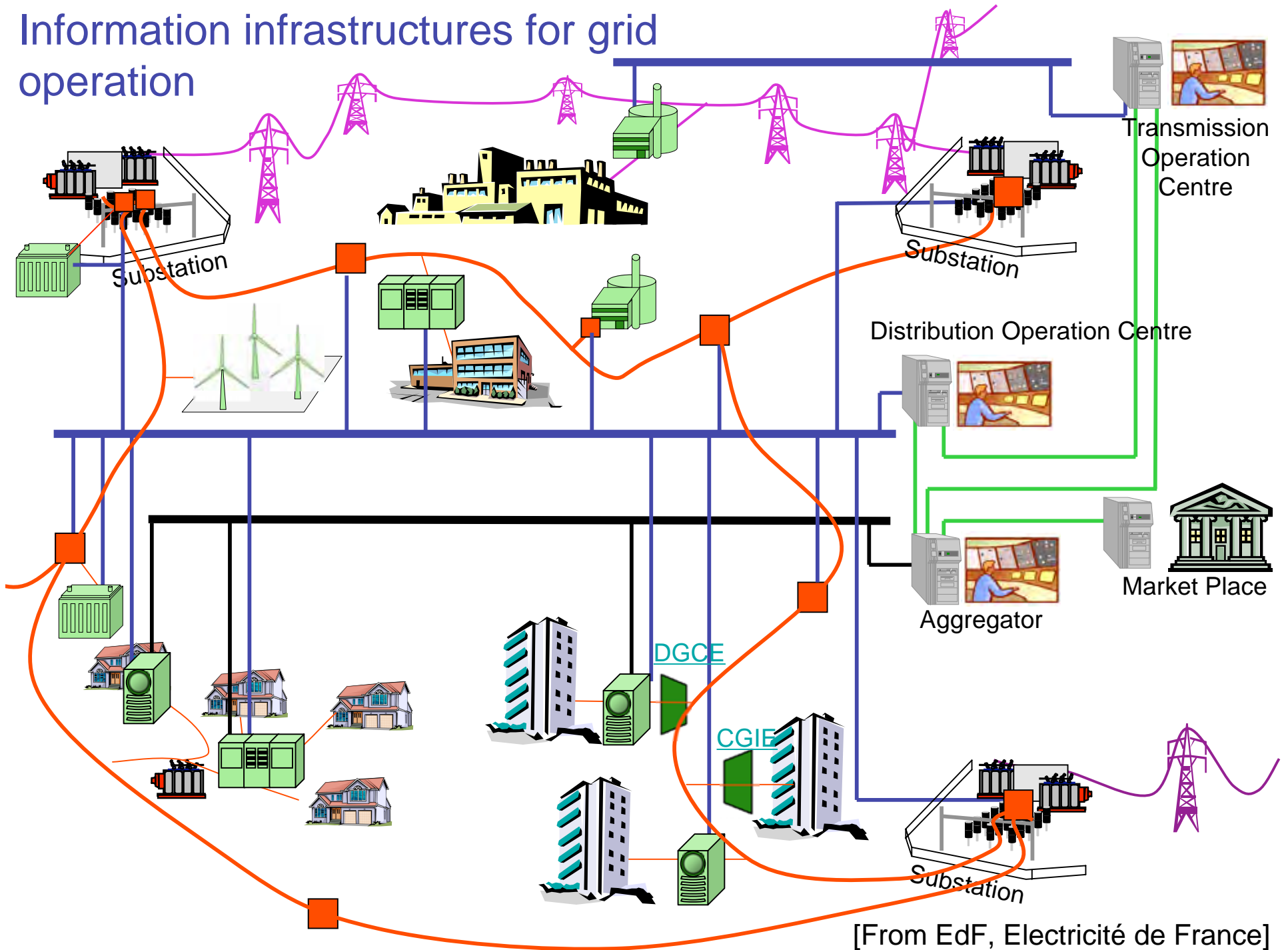

[From EdF, Electricité de France]

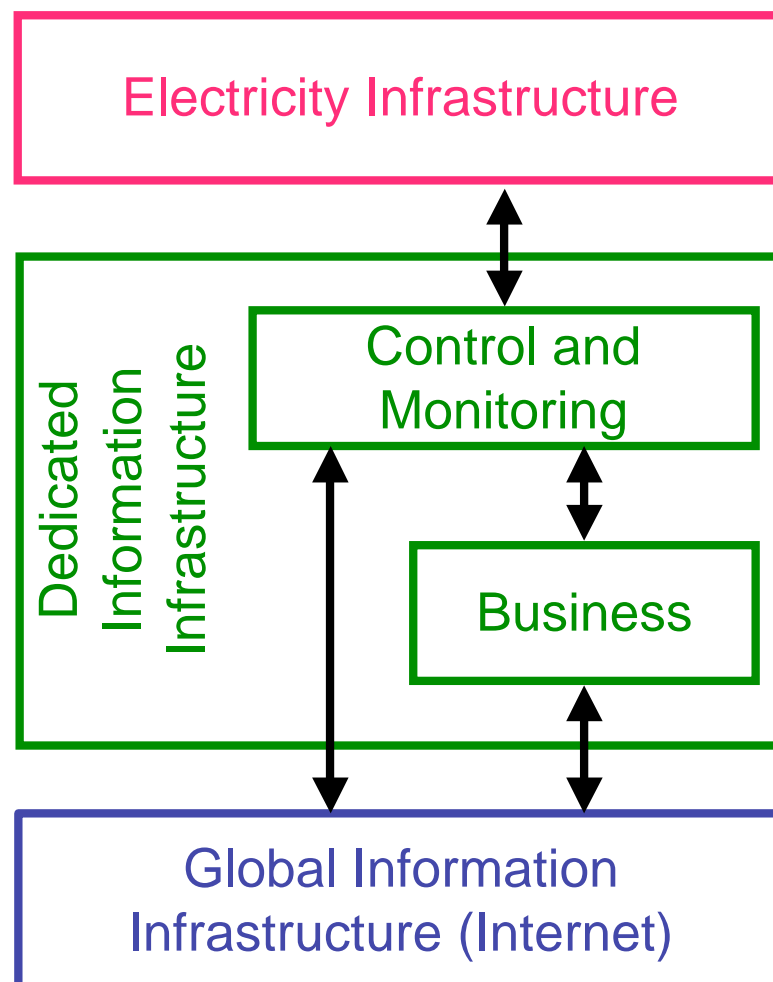
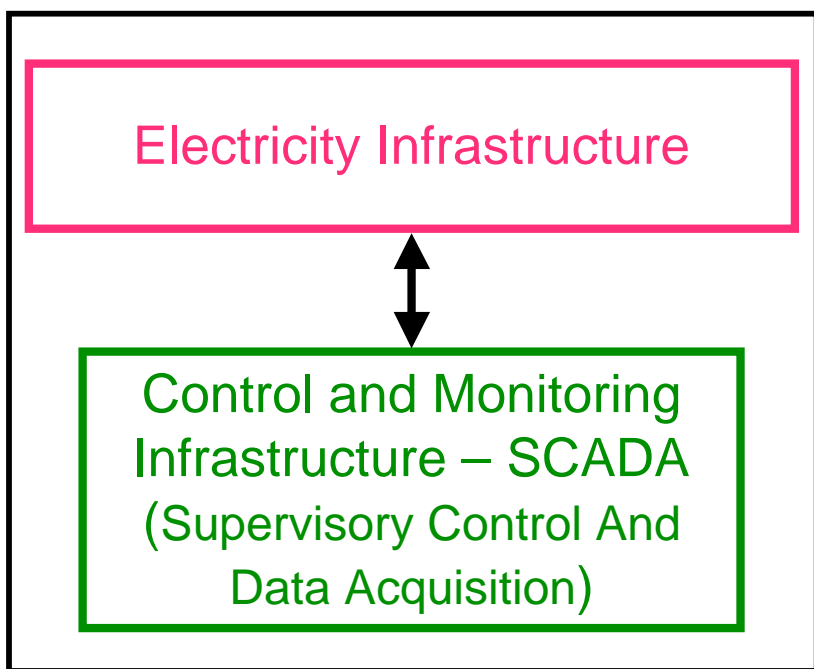
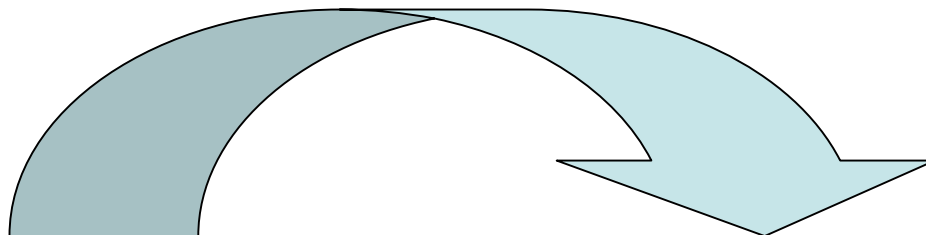

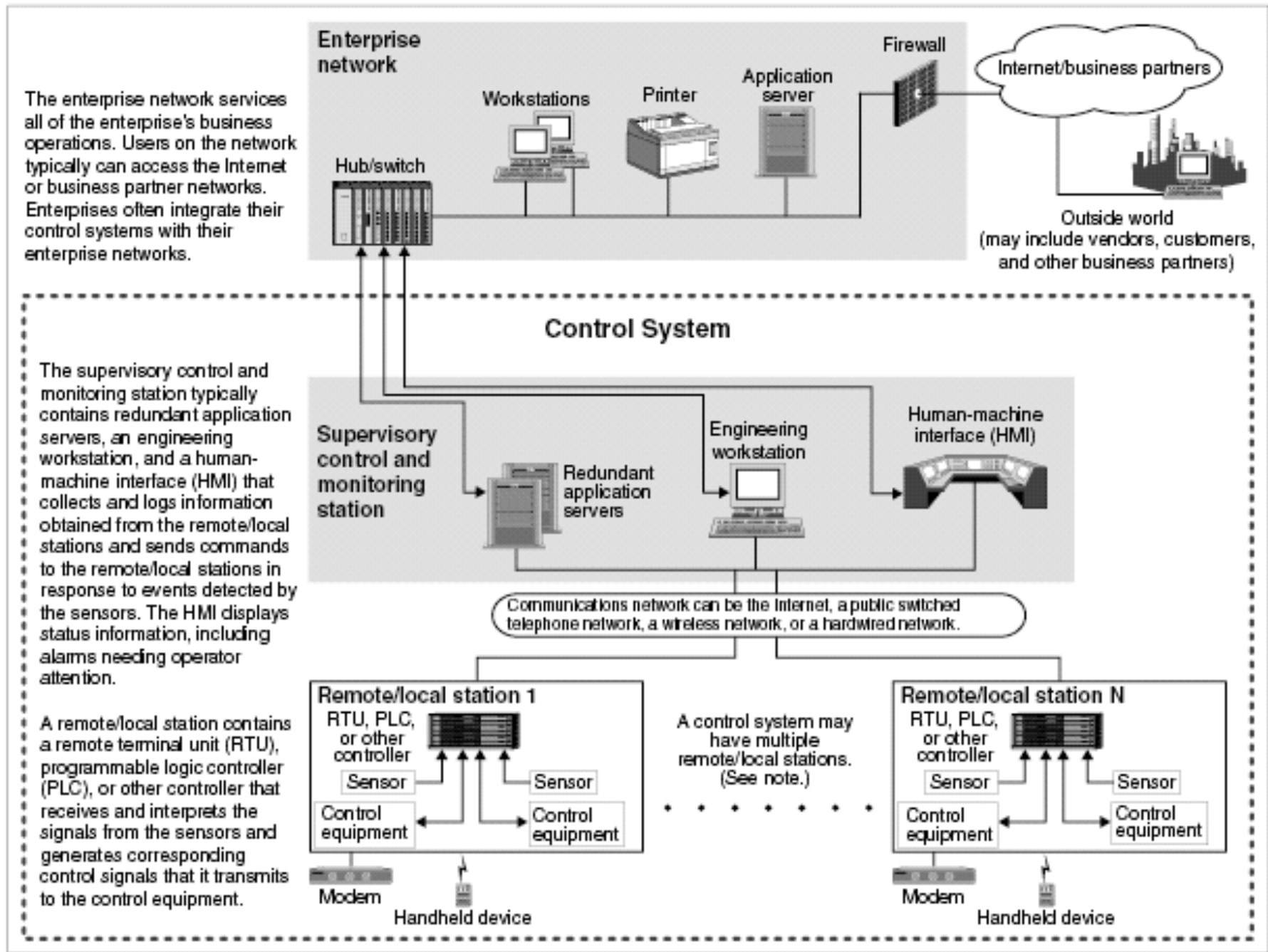

[Typical Components of a Control System, from GAO report on Critical Infrastructure Protection, March 2004]

# Interdependence-related outages

Cascading outage	an outage in one infrastructure causes an outage in another infrastructure
Escalating outage	an outage in one infrastructure exacerbates an outage of a second infrastructure, generally in the form of increasing the severity or the time for recuperation of the second infrastructure
Common-cause outage	two or more infrastructures exhibit the outage in concomitance, due to some common cause, either internal or external

## Examples

- Cascading outage: August 2003 - Infection and disabling of a safety monitoring system by the SQL Slammer worm at a nuclear power plant in Ohio
- Escalating outage: August 2003 - Contribution of an alarm software failure to the blackout propagation in Northwest USA and Canada
- Common-cause outage: March 1989 - Magnetic storm in Quebec, due to solar storm

# Models

Qualitative: (likely) scenarios of outage behavior of infrastructures, consecutive to accidental failures and malicious attacks

Global: no explicit modeling of infrastructure components

## Characterization

- Focus primarily on cascading and escalating outages

Outage cascading from an infrastructure to another one



*Constraints* on the other infrastructure



Service degradation

e.g., lower performance, undue isolations, manual control

Electricity infrastructure: untimely configuration changes (unnecessary off-line trips of production plants or transmission lines)

Information infrastructure: partial power supply shortage (e.g., business infrastructure)



Generic	Information infrastructure	Electricity infrastructure
Normal operation	Working	Up
Outage	Failure	Disruption
Dysfunction	Partially failed	Partially down, Lost
Recuperation	Recovery	Restoration
Constrained	Lessened	Weakened

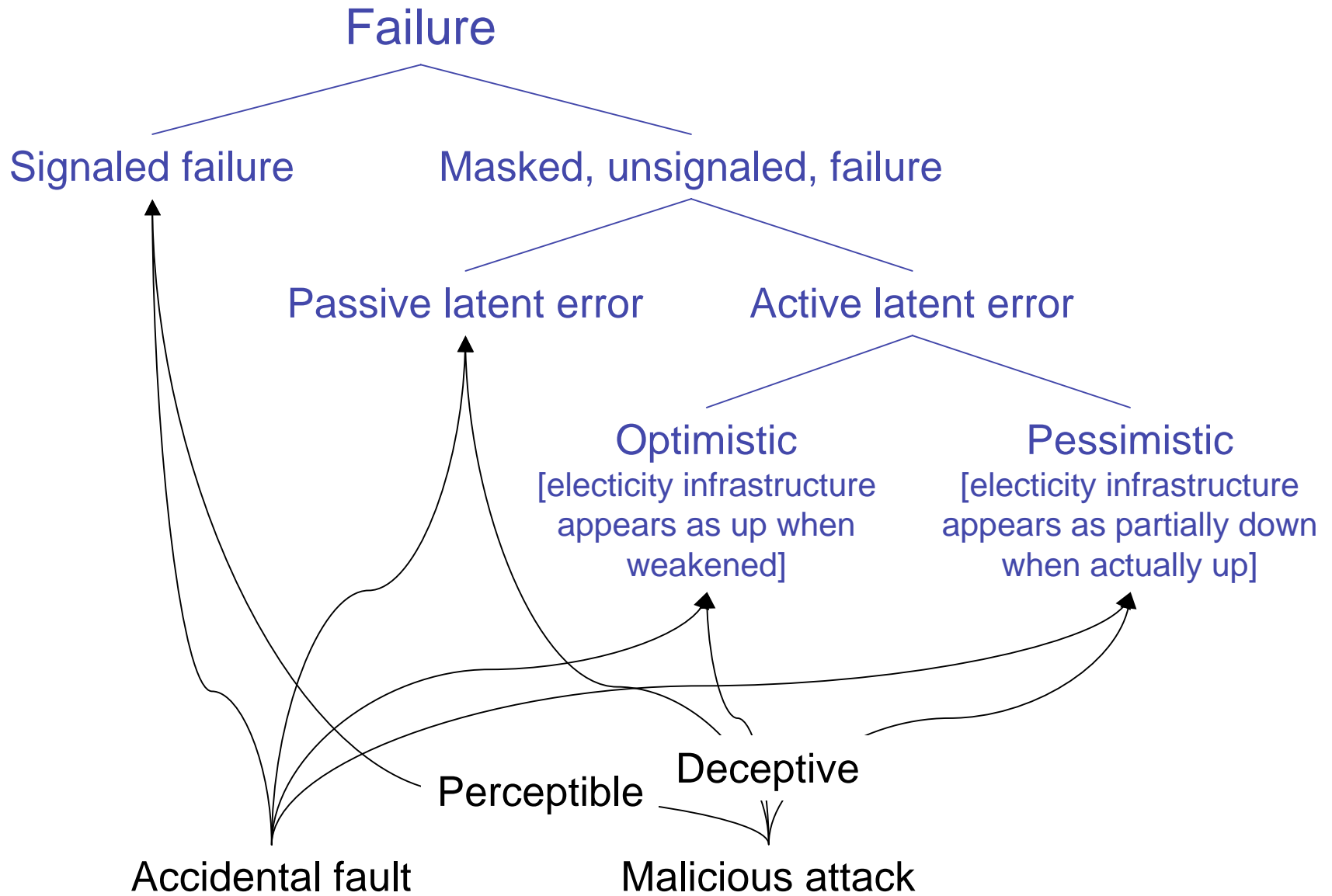

# Outage elementary models

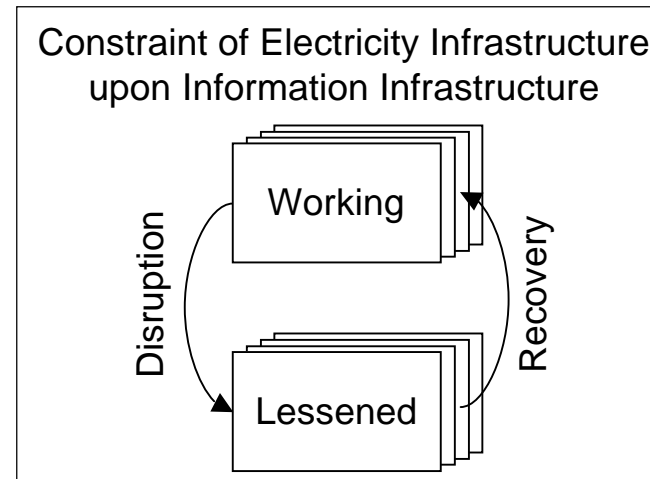
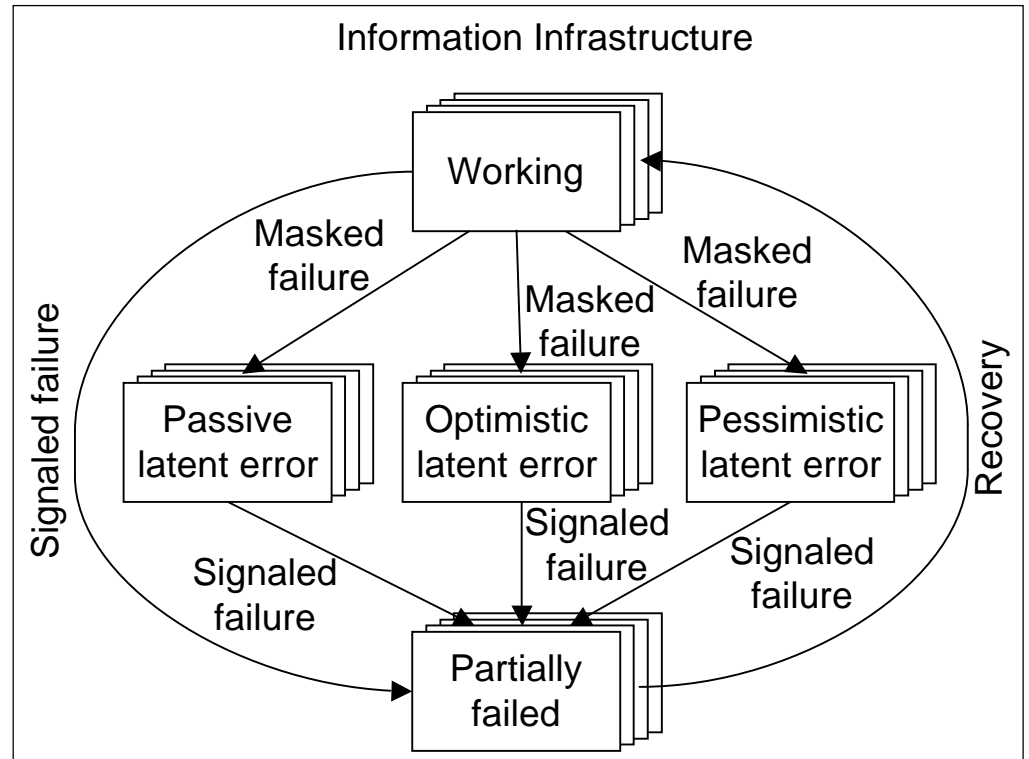
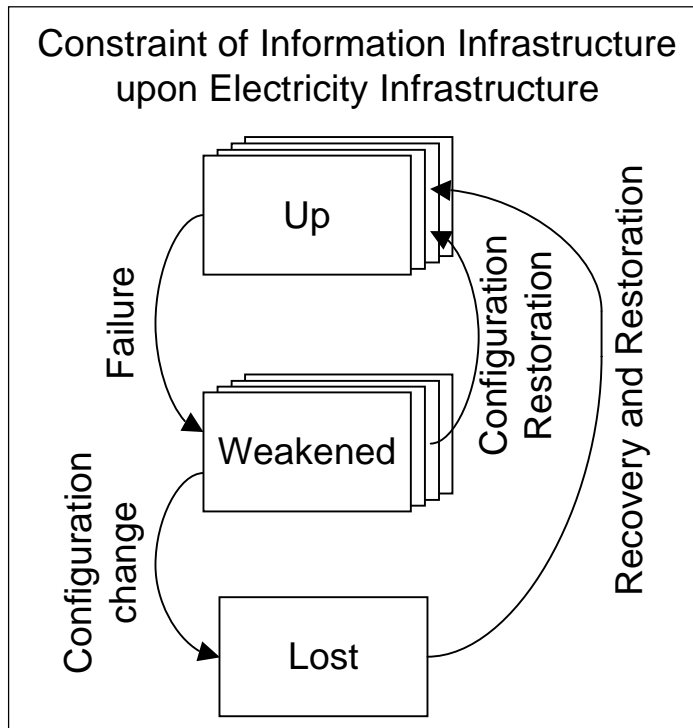
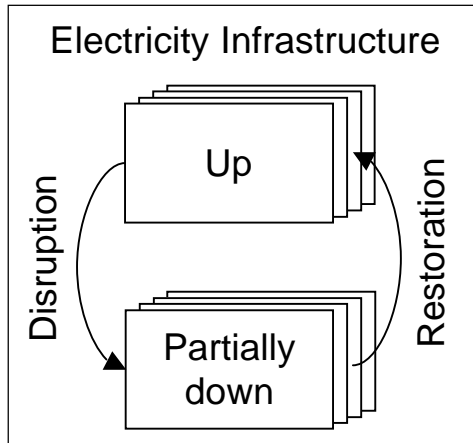

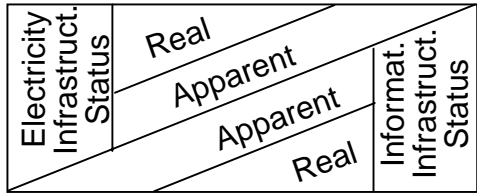

### Recovery and Configuration Restoration

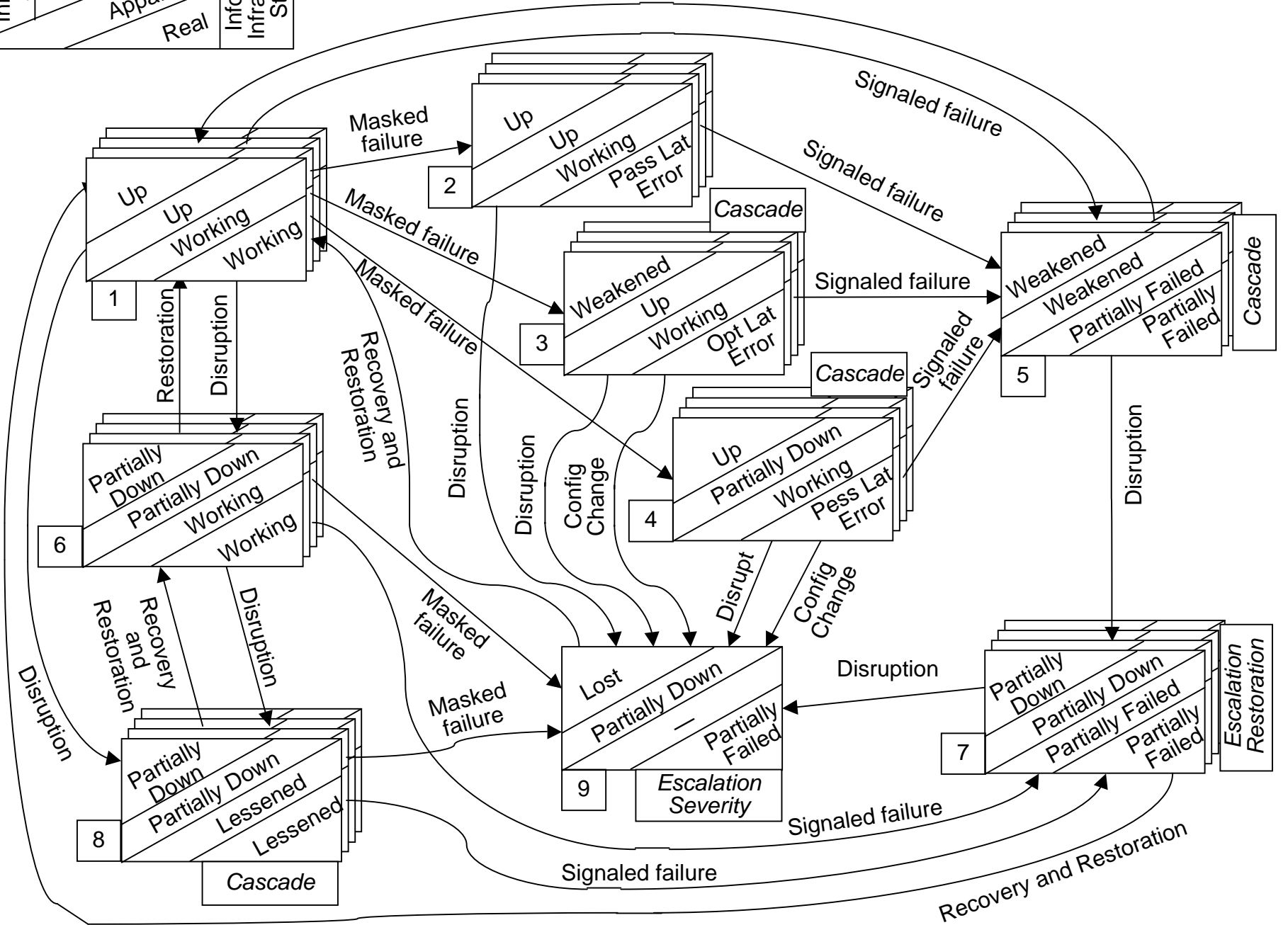

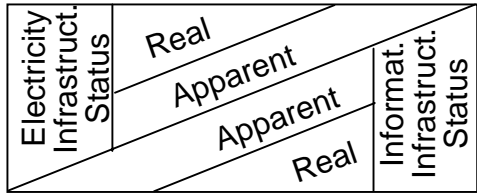

### Recovery and Configuration Restoration

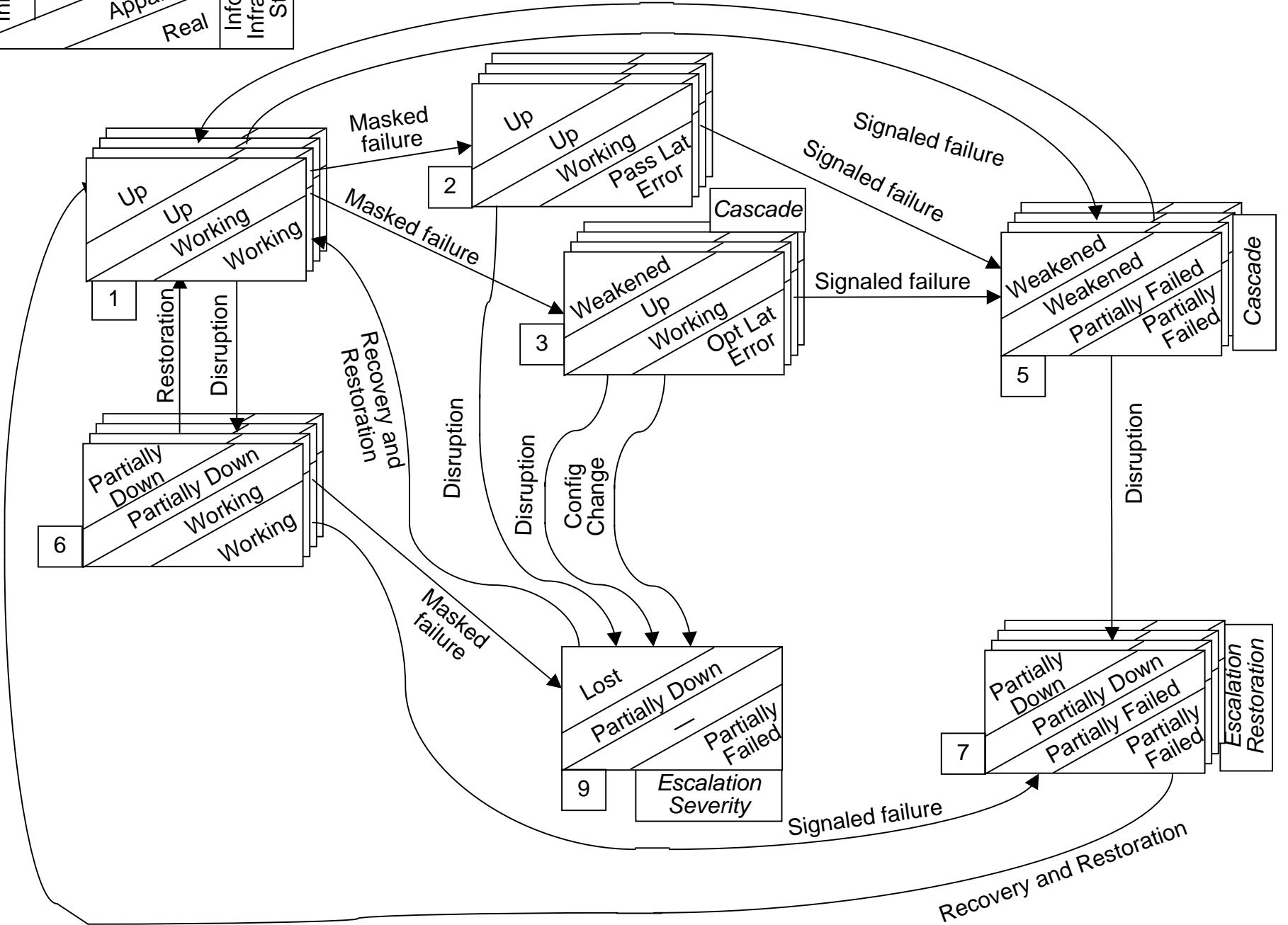

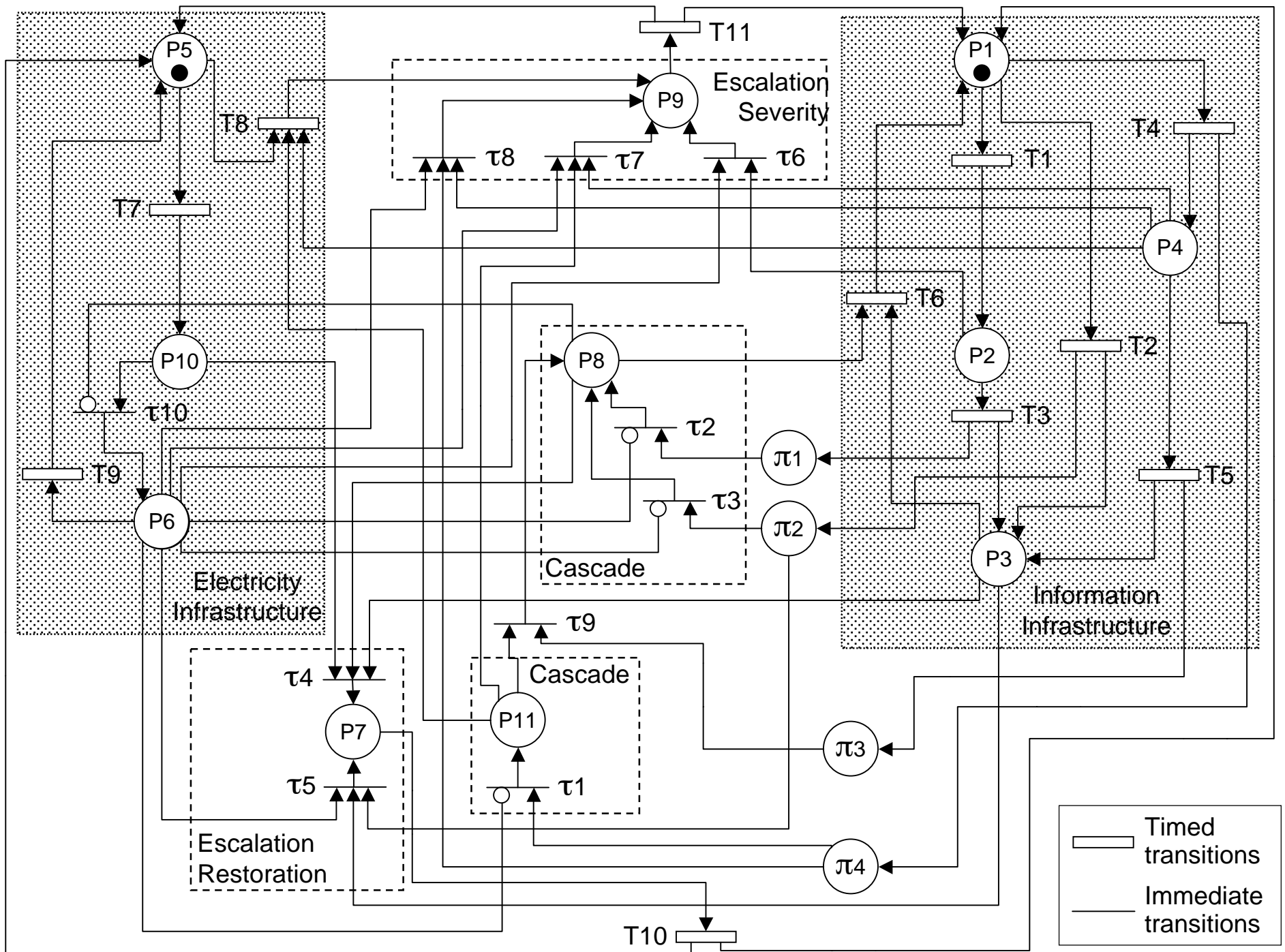

# Common-cause outages

Occurrence when infrastructures in normal operation

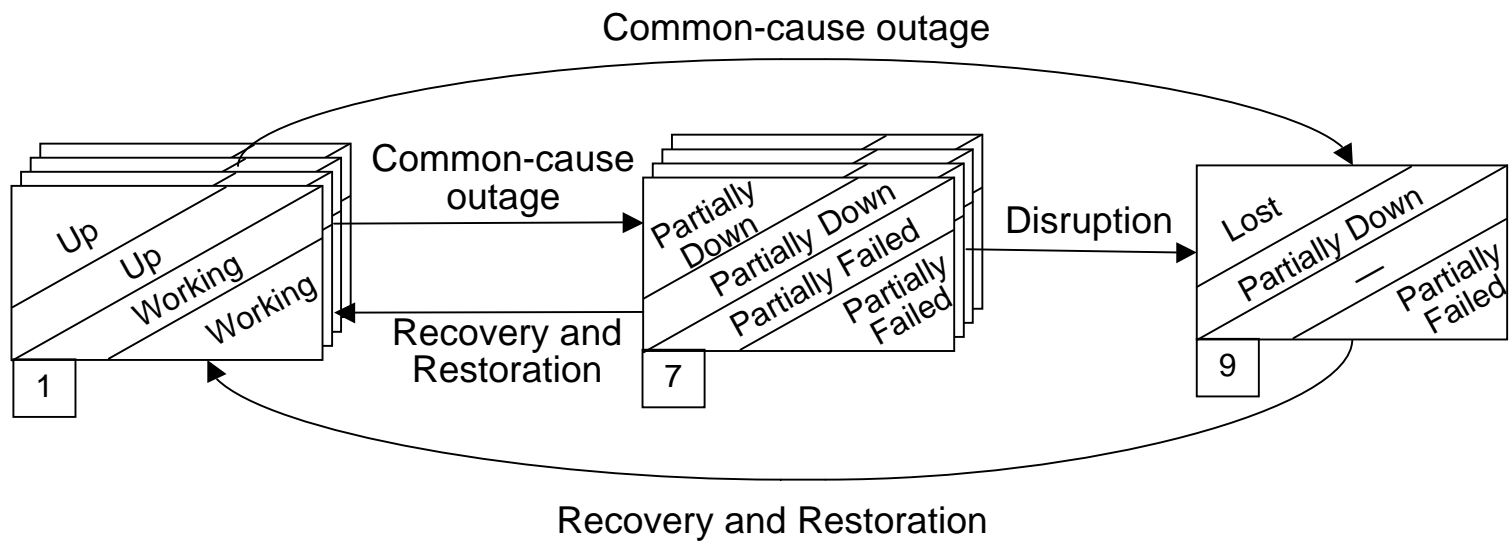

Occurrence in other states → states 7 or 9 (escalating)

# On-going work

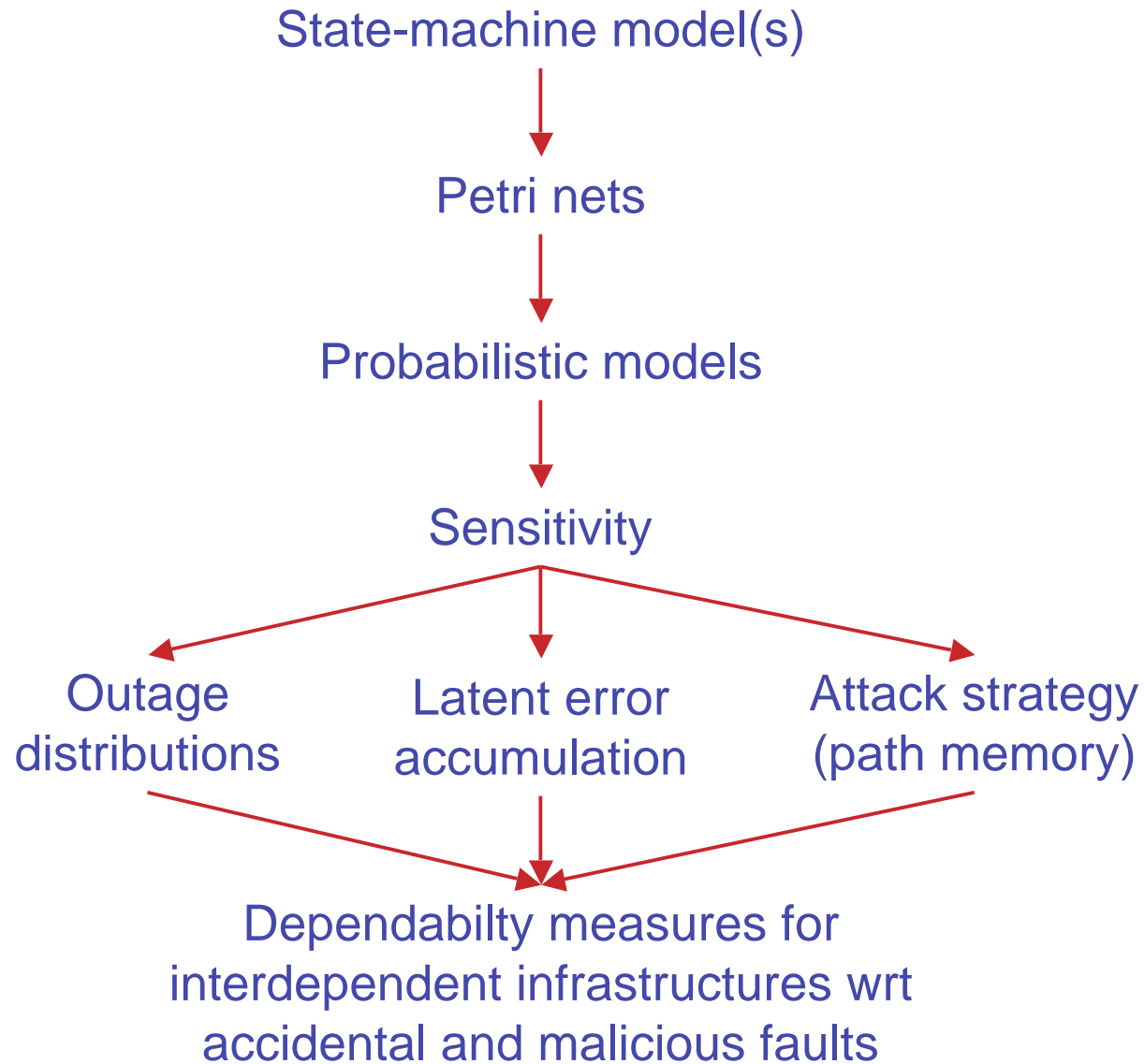



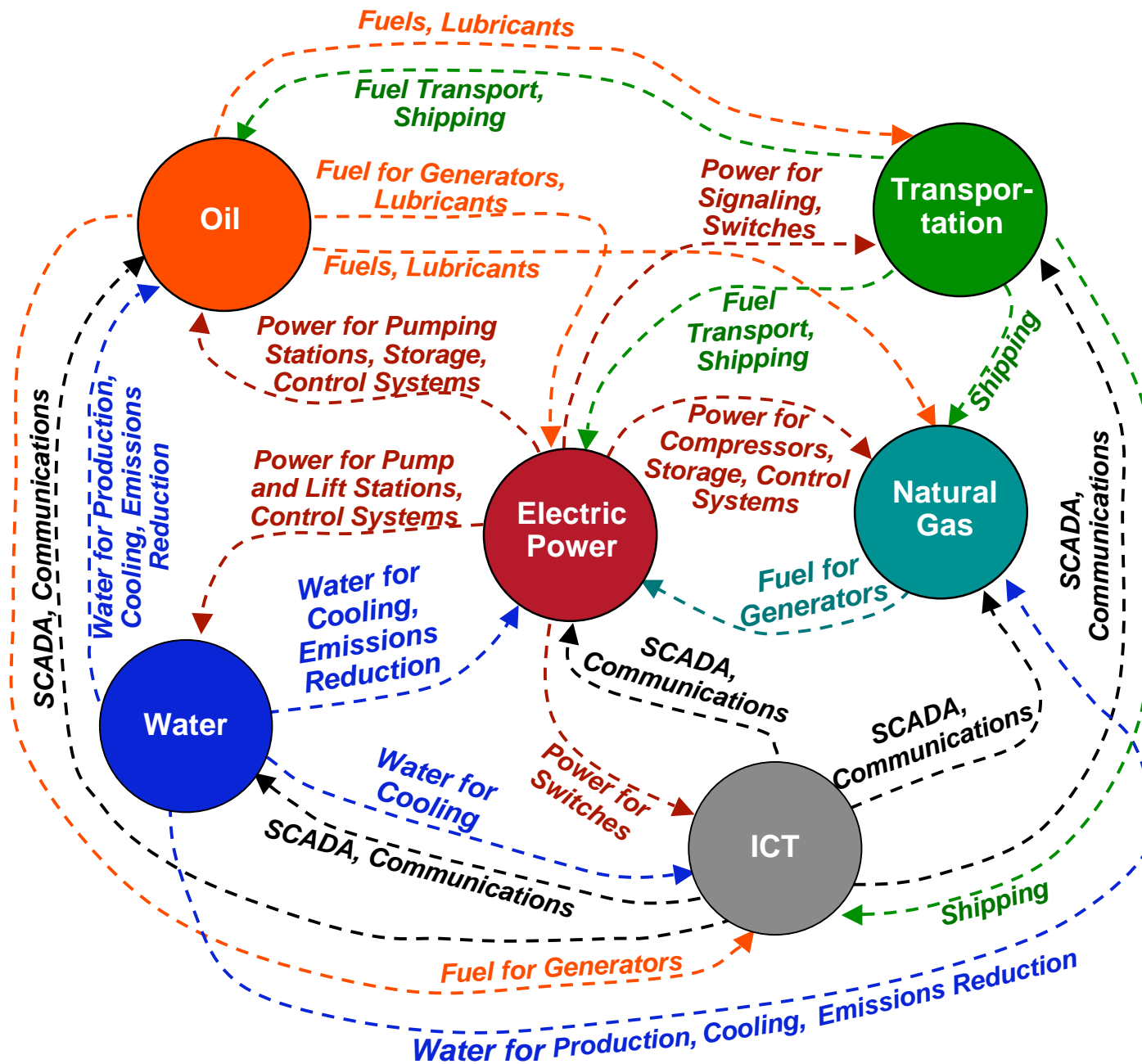

[From Rinaldi, Peerenboom, Kelly, 'Critical Infrastructure Interdependencies', IEEE Control Systems, Dec 2001, pp. 11-25]

## Critical infrastructures:

- IT Infrastructure
- Telecommunication Infrastructure
- Water Supply
- Electrical Power System
- Oil and Gas
- Road Transportation
- Railway Transportation
- Air Transportation
- Banking and Financial Services
- Public Safety Services
- Healthcare System
- Administration and Public Services

[From J. Moteff and P. Parformak, 'Critical Infrastructure and Key Assets: Definition and Identification', Congressional Research Service Report for Congress, Oct. 2004]

# Analysis of 347 documented computer-related infrastructure failures

[From H.A. Rahman, K. Beznosov, J.R. Marti, 'Identification of sources of failures and their propagation in critical infrastructures from 12 years of public failure reports', Proc. CRIS 2006, 3rd Int Conf on Critical Infrastructures]

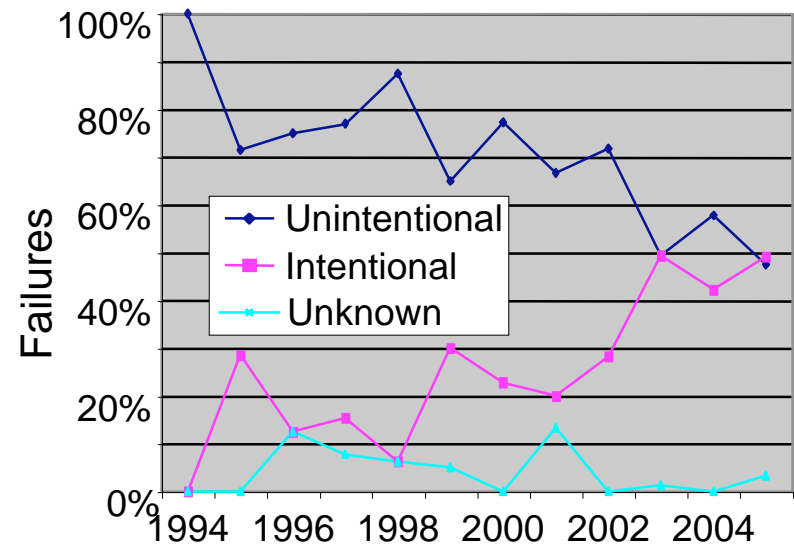
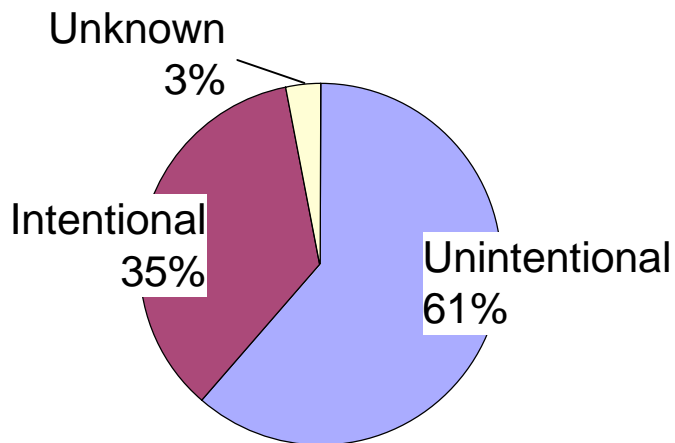
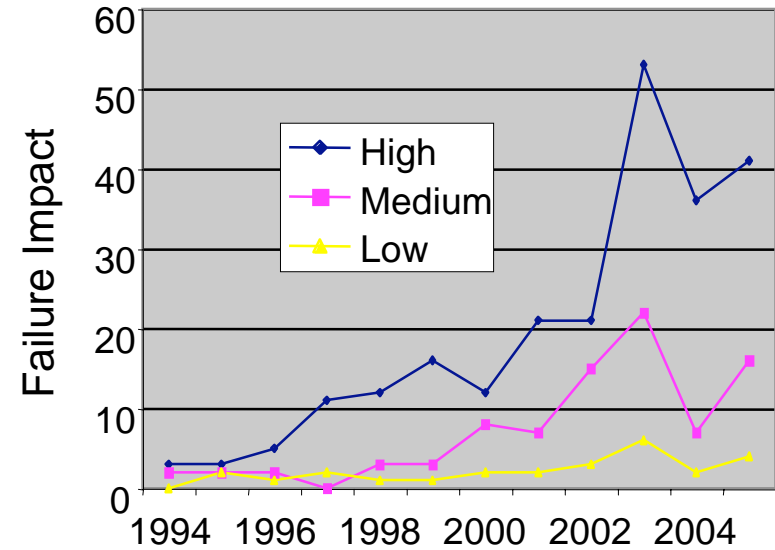
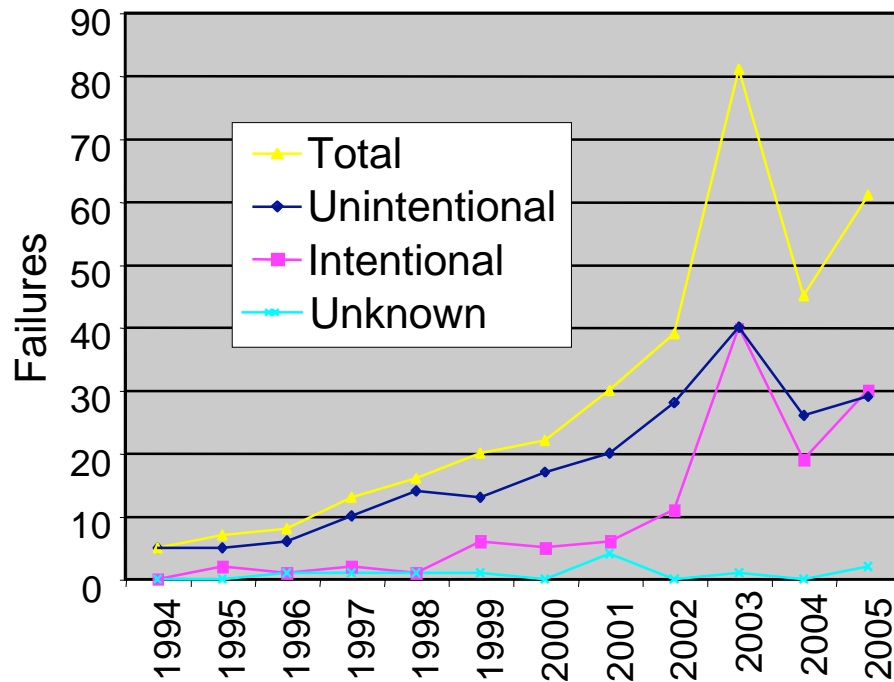

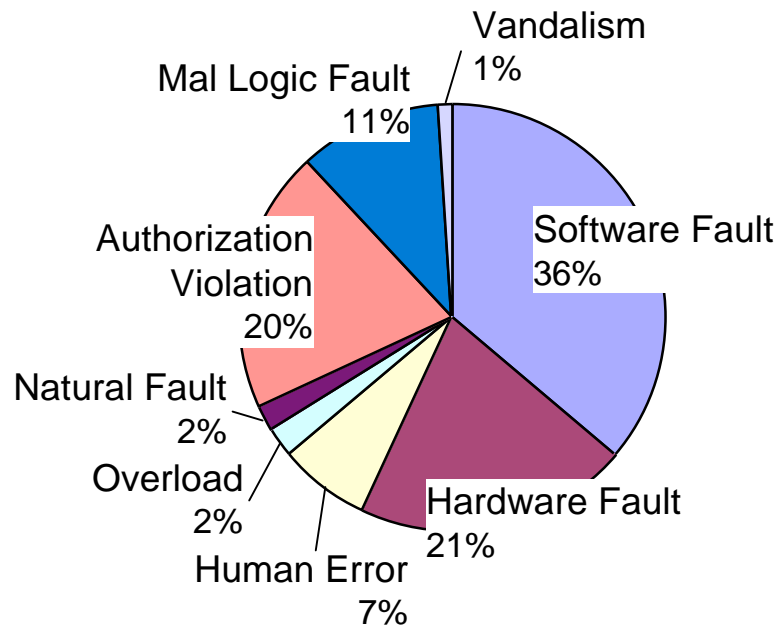

Faults that lead to infrastructure failure

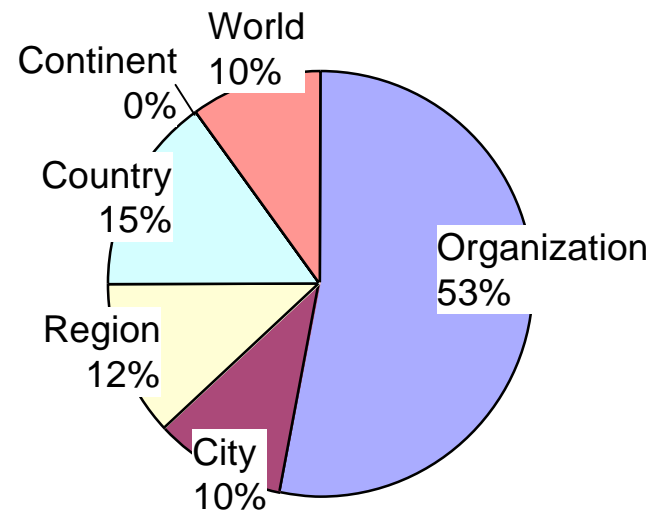

Localities affected by infrastructure failures

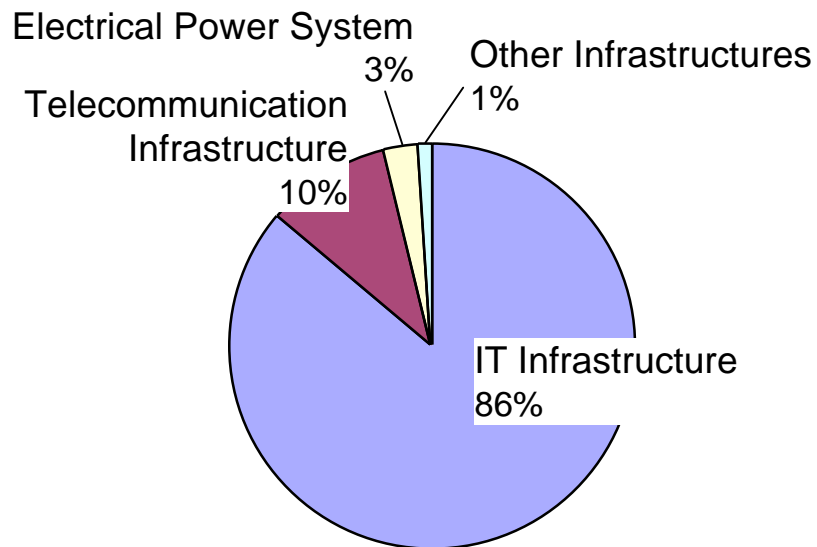

Infrastructure failure source that affect IT infrastructure

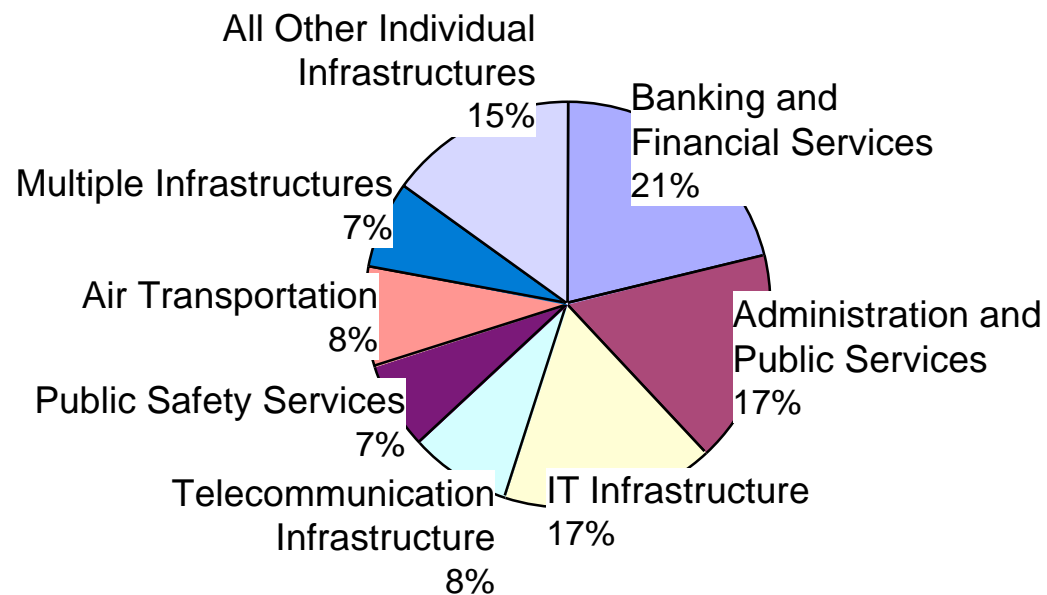

Infrastructures affected due to IT infrastructure failure